

SynQor®

MCOTS-B-900-28-FT
Single Output
Full-brick

Military COTS DC-DC Bus Converters

800-1000 V Input	28 V Output	107 A Current	4250 Vdc Isolation	Full-brick DC-DC Converter
----------------------------	-----------------------	-------------------------	------------------------------	--------------------------------------

Operating Temperature Range is -55 °C to +100 °C

The MCOTS-B-900-28-FT bus converter is a next-generation, board-mountable, isolated, fixed switching frequency DC-DC converter that uses synchronous rectification to achieve extremely high conversion efficiency. The MCOTS series provides an isolated step down voltage from 900 V to 28 V intermediate bus with no regulation in a standard full-brick module. MCOTS-B-900-28-FT converter is ideal for creating the mid-bus voltage required to drive standard 28 V DC-DC isolated converters.

MilCOTS™



Designed and manufactured in the USA.

Protection Features

- Input under-voltage and over voltage lockout protects against abnormal input voltages
- Output current limit and short circuit protection (auto recovery)
- Thermal shutdown

Control Features

- On/Off control referenced to input side
- Inherent current share (by droop method) for high current and parallel applications.
- Clock synchronization (primary referenced)

Mechanical Features

- Industry standard full-brick pin-out configuration
- Size: 2.486" x 4.686" x .512" (63.14x119.02x13.00 mm)
- Total Encased weight: 10.0 oz (285g)

Operational Features

- High efficiency, 96.8% at full rated load current
- Delivers 107 A full power with minimal derating
- Operating input voltage range: 800-1000 V
- Fixed frequency switching provides predictable EMI
- No minimum load requirement

Safety Features

- 4250 Vdc, 100 MΩ input-to-output isolation

Screening/Qualification

- AS9100 and ISO 9001 certified facility
- Qualification consistent with MIL-STD-883
- Available with S-Grade or M-Grade screening
- Pre-cap inspection per IPC-A-610, Class III
- Temperature cycling per MIL-STD-883, Method 1010, Condition B, 10 cycles
- Burn-In at 100 °C baseplate temperature
- Final visual inspection per MIL-STD-883, Method 2009
- Full component traceability



Block Diagram

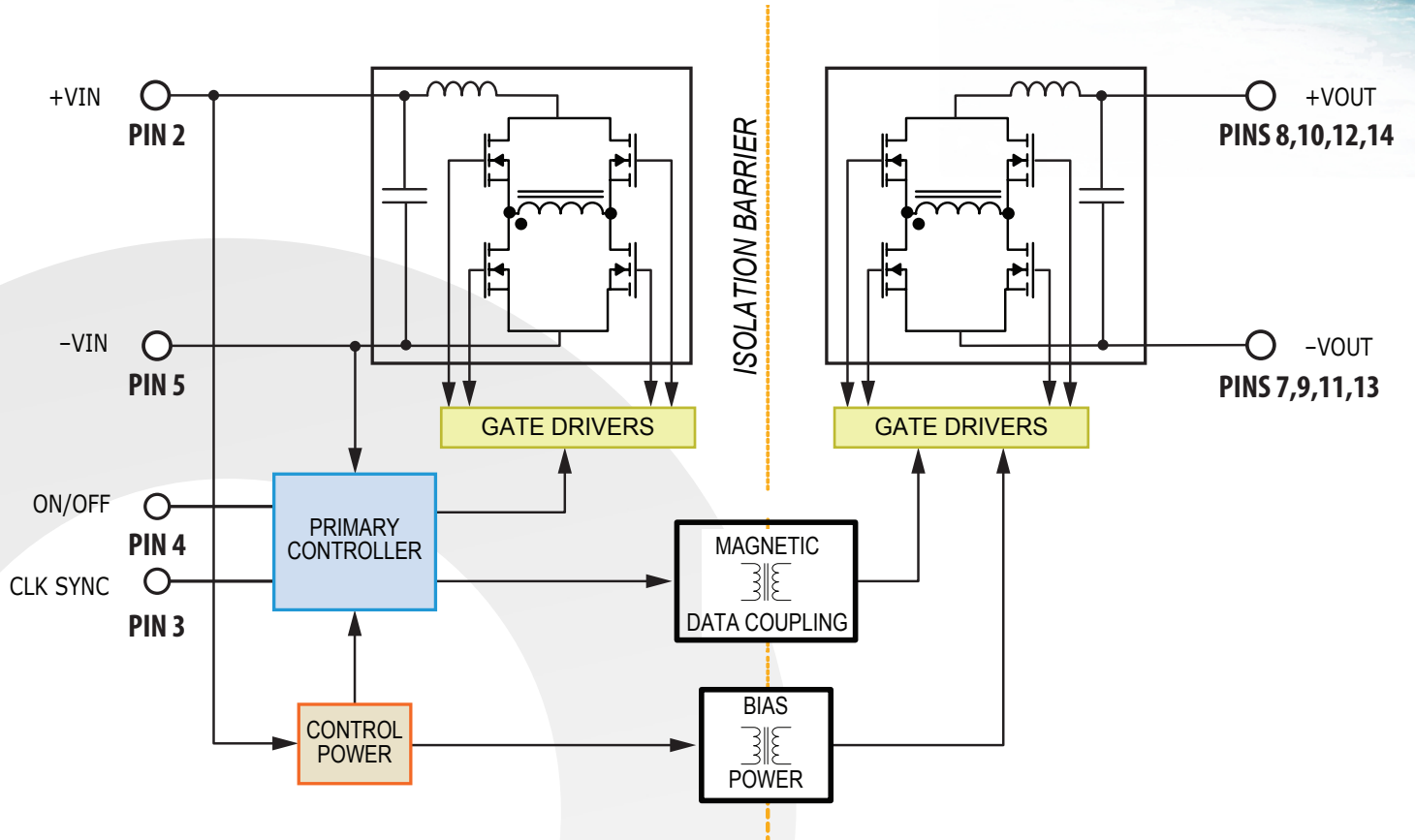



MCOTS-B-900-28-FT
Input: 800-1000 V
Output: 28 V
Current: 107 A

Electrical Characteristics

MCOTS-B-900-28-FT Electrical Characteristics

Ta = 25 °C, airflow rate = 300 LFM, Vin = 900 Vdc unless otherwise noted; full operating temperature range is -55 °C to less than +100 °C (nominal-line, high-line), +100 °C (low-line) baseplate temperature with appropriate power derating. Specifications subject to change without notice.

Parameter	Min.	Typ.	Max.	Units	Notes & Conditions
ABSOLUTE MAXIMUM RATINGS					
Input Voltage					
Non-Operating	-0.5		1200	V	Continuous
Operating			1050	V	See Note 1
Isolation Voltage					
Input to Output			4250	Vdc	See Note 6
Input to Baseplate			2300	Vdc	See Note 6
Output to Baseplate			2300	Vdc	See Note 6
Operating Temperature	-55		100	°C	
Storage Temperature	-65		135	°C	
Voltage at ON/OFF input pin	-2		18	V	
INPUT CHARACTERISTICS					
Operating Input Voltage Range	800	900	1000 1050	V	Continuous Transient, 100 ms, dv/dt < 0.5 V/μs
Input Under-Voltage Lockout					See Figure 11
Turn-On Voltage Threshold		780		V	
Turn-Off Voltage Threshold		695		V	
Lockout Voltage Hysteresis		85		V	
Input Over-Voltage Shutdown					See Figure 11
Turn-On Voltage Threshold		1030		V	
Turn-Off Voltage Threshold > 0.1 s		1055		V	
Turn-Off Voltage Threshold		1075		V	
Maximum Input Current			4.1	A	
No-Load Input Current		30		mA	
Disabled Input Current		3		mA	
Input Reflected-Ripple Current		520		mA	RMS through 10 μH inductor - full load
Input Terminal-Ripple Current		455		mA	RMS, full load
Recommended Input Fuse (see Note 2)			10	A	Fast blow external fuse recommended
Recommended External Input Capacitance		4.7		μF	Typical ESR 0.1-0.2 Ω
Input Filter Component Values (L\C)		22\0.18		μH\μF	Internal values
OUTPUT CHARACTERISTICS					
Output Voltage Set Point		28		V	Vin = 900 V, Io = 0 A, effective turns ratio 32:1
Output Voltage Regulation					
Over Line		22.5\6.3		%\V	
Over Load		5.2\1456		%\mV	Vin = 900 V
Over Temperature		1.5\430		%\mV	Vin = 900 V, 3kW load
Total Output Voltage Range	23.7		32.1	V	Over sample, line, load, temperature & life
Output Voltage Ripple and Noise					20 MHz bandwidth; see Note 3
Peak-to-Peak		258		mV	Full load
RMS		21		mV	Full load
Operating Output Current Range	0		107	A	Subject to thermal derating; see Figure 5
Output DC Current-Limit Inception		127		A	Vin = 900 V; see Figure 6
Back-Drive Current Limit while Disabled		0.7		mA	Negative current drawn from output
Maximum Output Capacitance			9,000	μF	28 Vout at 53 A Resistive Load
EFFICIENCY					
100% Load		96.8		%	
50% Load		97		%	

MCOTS-B-900-28-FT Electrical Characteristics (continued)

Ta = 25 °C, airflow rate = 300 LFM, Vin = 900 Vdc unless otherwise noted; full operating temperature range is -55 °C to less than +100 °C (nominal-line, high-line), +100 °C (low-line) baseplate temperature with appropriate power derating. Specifications subject to change without notice.

Parameter	Min.	Typ.	Max.	Units	Notes & Conditions
DYNAMIC CHARACTERISTICS					
Output Voltage during Load Current Transient					
Step Change in Output Current (0.1 A/μs)		160		mV	50% to 75% to 50% of Iout max
Settling Time		40		μs	To within 1% Vout nom
Turn-On Transient					
Turn-On Time (with 3 mF output capacitance)		110		ms	Half load (resistive), Vout=90% nom; Note 4
Start-Up Inhibit Time		320		ms	Figure F
Output Voltage Overshoot		0		%	9 mF load capacitance with half resistive load
ISOLATION CHARACTERISTICS					
Isolation Voltage (dielectric strength)			4250	V	See Absolute Maximum Ratings, Note 6
Isolation Resistance	100			MΩ	
Isolation Capacitance (input to output)		N/A		pF	Note 5
TEMPERATURE MODEL FOR POWER DERATING CURVES					
Semiconductor Junction Temperature			125	°C	Package rated to 150 °C
Board Temperature			125	°C	UL rated max operating temp 130 °C
Transformer Core Temperature			125	°C	
Maximum Baseplate Temperature, Tb			100	°C	
FEATURE CHARACTERISTICS					
Switching Frequency (fs)	150	175	200	kHz	Fundamental ripple frequency is 2 x fs
Clock Synchronization	300		400	kHz	Internal pull-up to 3.3V open drain, Note 7
ON/OFF Control					
On-State Voltage	-1		0.4	V	
Off-State Voltage	2		18	V	
ON/OFF Control					Application notes Figure B
Pull-Up Voltage		5		V	
Pull-Up Resistance		82.5		kΩ	
Over-Temperature Shutdown OTP Trip Point	140		150	°C	Average PCB Temperature
Over-Temperature Shutdown Restart Hysteresis		10		°C	
RELIABILITY CHARACTERISTICS					
Calculated MTBF (MIL-217) MIL-HDBK-217F		416		10 ³ Hrs.	Ground Benign, 70°C Tb
Calculated MTBF (MIL-217) MIL-HDBK-217F		50.7		10 ³ Hrs.	Ground Mobile, 70°C Tb

Note 1: Converter will undergo input over-voltage shutdown.

Note 2: An external fuse is required for safe operation.

Note 3: For applications requiring reduced output voltage ripple and noise, consult SynQor applications support (e-mail: support@synqor.com)

Note 4: Starting up under full load can result in hic-up operation (shut down).

Note 5: No capacitors cross the isolation barrier within the converter. Isolation capacitance can be added external to the module.

Note 6: 1 minute for qualification test, and less than 1 minute in production.

Note 7: Injecting more than 100mA can cause damage. Adding more than 100pF can prevent Synchronization.



Technical Charts

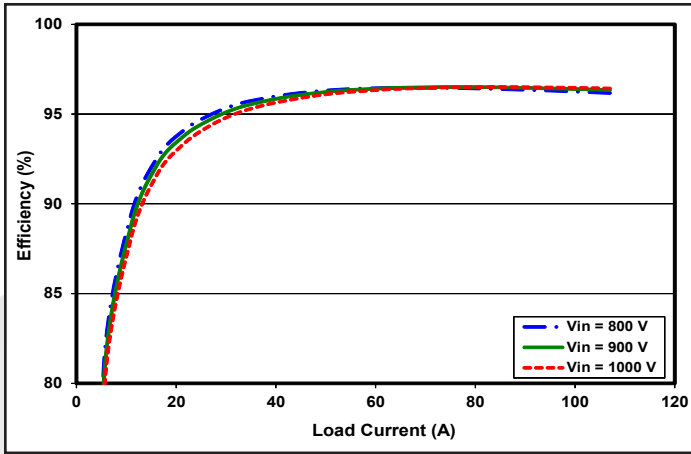

Figure 1: Efficiency at nominal output voltage vs. load current for minimum, nominal, and maximum input voltage at 25 °C.

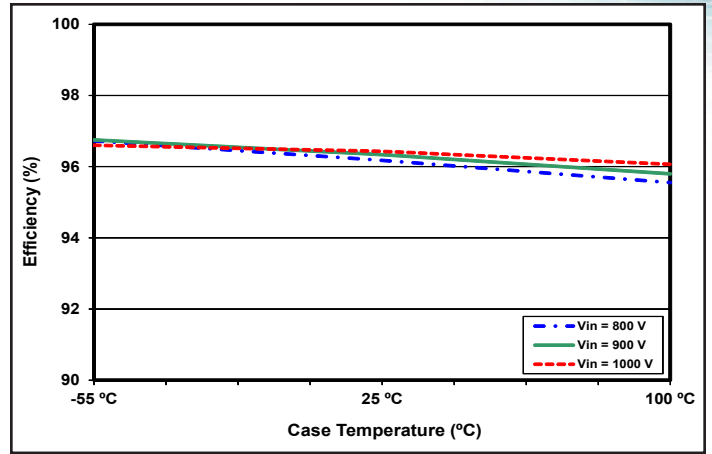

Figure 2: Efficiency vs. case temperature for minimum, nominal, and maximum input voltage and 100% rated power.

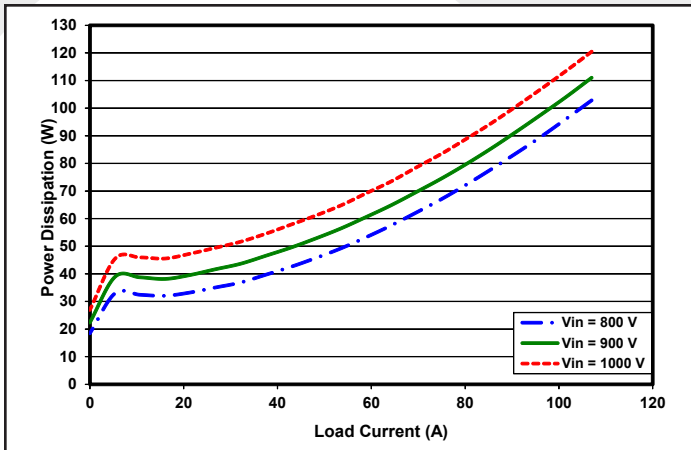

Figure 3: Power dissipation vs. load current for minimum, nominal, and maximum input voltage at $T_{CASE}=25\text{ }^{\circ}\text{C}$.

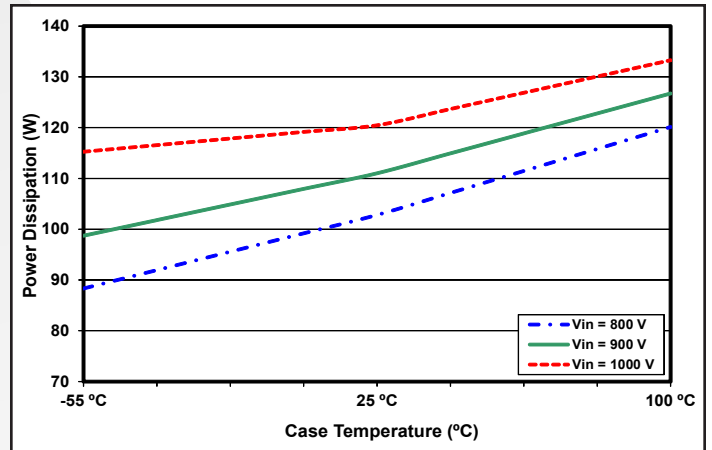

Figure 4: Power dissipation vs. case temperature for minimum, nominal, and maximum input voltage and 100% rated power.

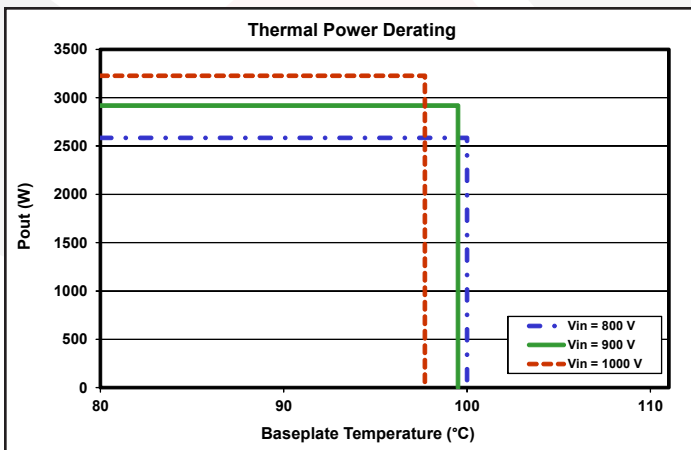

Figure 5: Maximum output power vs. baseplate temperature for minimum, nominal, and maximum input voltage.

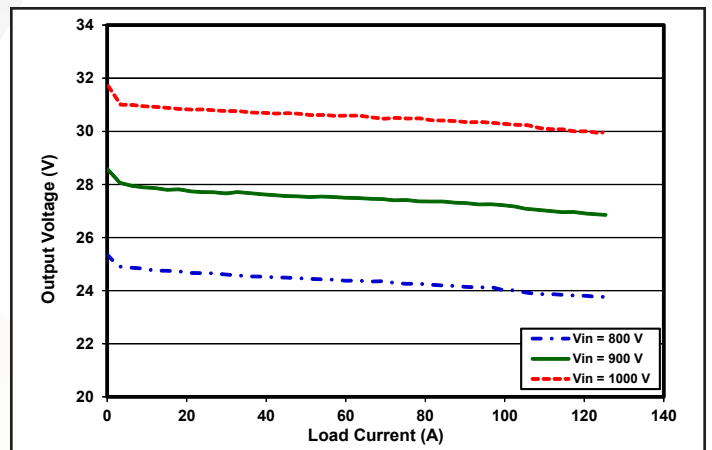

Figure 6: Output voltage vs. load current, current limit curves for minimum, nominal, and maximum input voltage at $T_{CASE}=25\text{ }^{\circ}\text{C}$.



MCOTS-B-900-28-FT
Input: 800-1000 V
Output: 28 V
Current: 107 A

Technical Charts

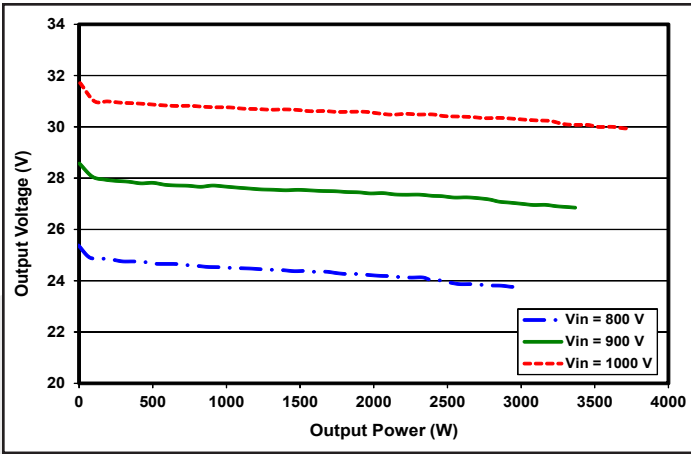

Figure 7: Output voltage vs. output power, regulation curves for minimum, nominal, and maximum input voltage at $T_{CASE}=25\text{ }^{\circ}\text{C}$.

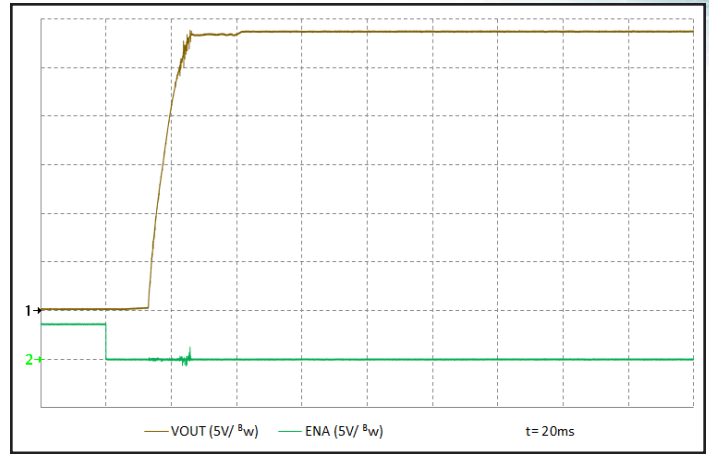

Figure 8: Turn-on transient at no load and 470uF output capacitance initiated by ENA. Input voltage pre-applied. Ch 1: Vout (5 V/div). Ch 2: ENA (5 V/div). Timescale: 20.0ms/div. Bandwidth: 20Mhz.

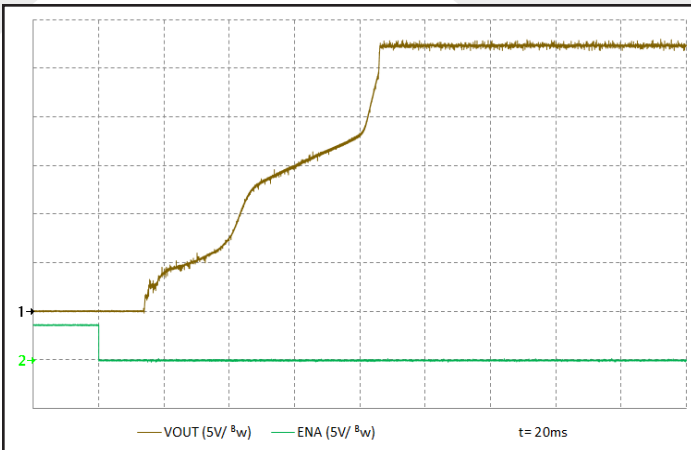

Figure 9: Turn-on transient at half resistive load and 100 uF output capacitance initiated by ENA. Input voltage pre-applied. Ch 1: Vout (5 V/div). Ch 2: ENA (5 V/div). Timescale: 20.0ms/div. Bandwidth: 20 Mhz.

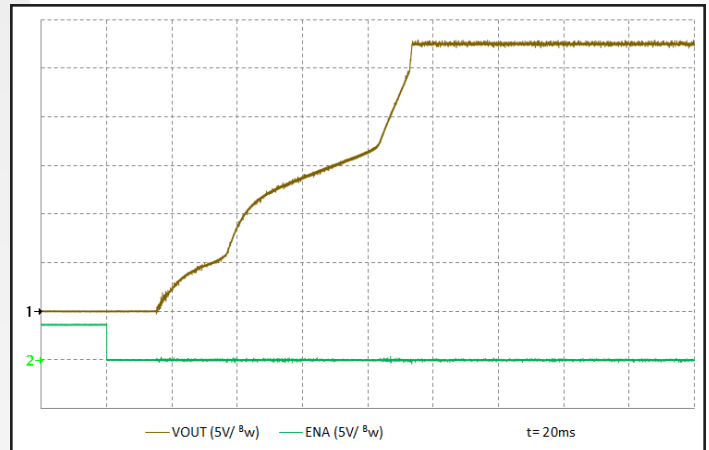

Figure 10: Turn-on transient at half resistive load and 9 mF output capacitance initiated by ENA. Input voltage pre-applied. Ch 1: Vout (5 V/div). Ch 2: ENA (5 V/div). Timescale: 20.0ms/div. Bandwidth: 20 Mhz.

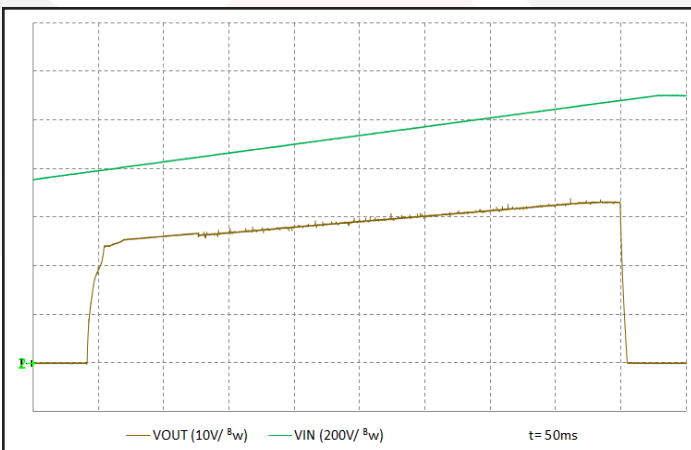

Figure 11: Under-Voltage Lockout and Over-Voltage Shutdown behavior as a function of V_{in} . ENA previously enabled. 100uF output capacitance Ch 1: Vout (10 V/div). Ch 2: Vin (200 V/div). Timescale: 50.0ms/div. Bandwidth: 20 Mhz.

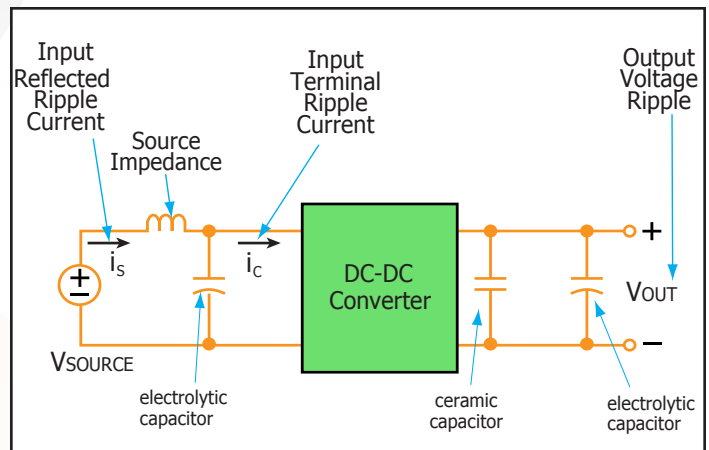

Figure 12: Test set-up diagram showing measurement points for Input Terminal Ripple Current (Figure 16) and Output Voltage Ripple (Figure 17).



MCOTS-B-900-28-FT
Input: 800-1000 V
Output: 28 V
Current: 107 A

Technical Charts

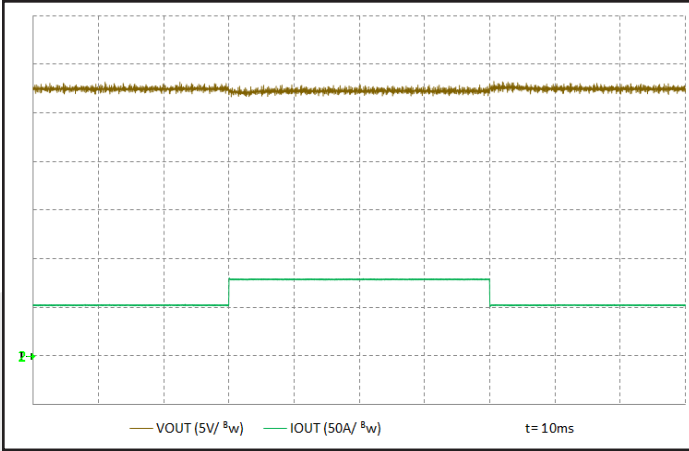

Figure 13: Output voltage response to step-change in load current 50%-75%-50% of $I_{out(max)}$, 470uF output capacitance. Ch 1: V_{out} (5 V/div) Ch 2: I_{out} (50A/div). Bandwidth: 20 MHz. Timescale: 10.0ms/div.

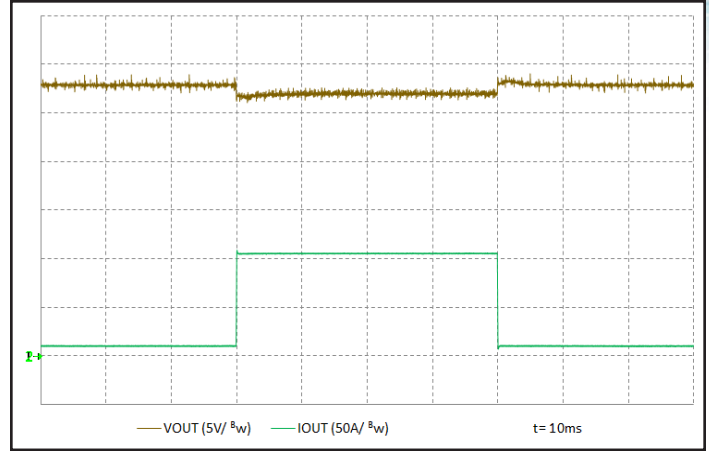

Figure 14: Output voltage response to step-change in load current 10%-100%-10% of $I_{out(max)}$, 470uF output capacitance. Ch1: V_{out} (5 V/div). Ch 2: I_{out} (50 A/div). Bandwidth: 20 MHz. Timescale: 10.0ms/div.

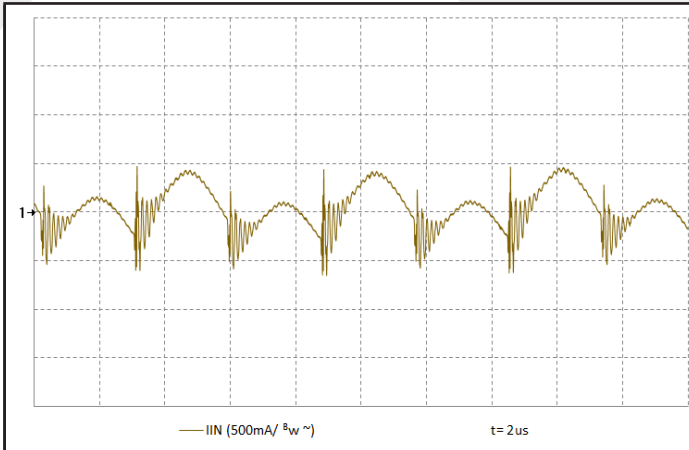

Figure 15: Input terminal ripple, i_c , at full load and nominal input voltage with 10 μ H source impedance and 110 μ F electrolytic capacitor (500 mA/div). Bandwidth: 20 MHz. Timescale: 2.00 μ s/div. See Figure 12.

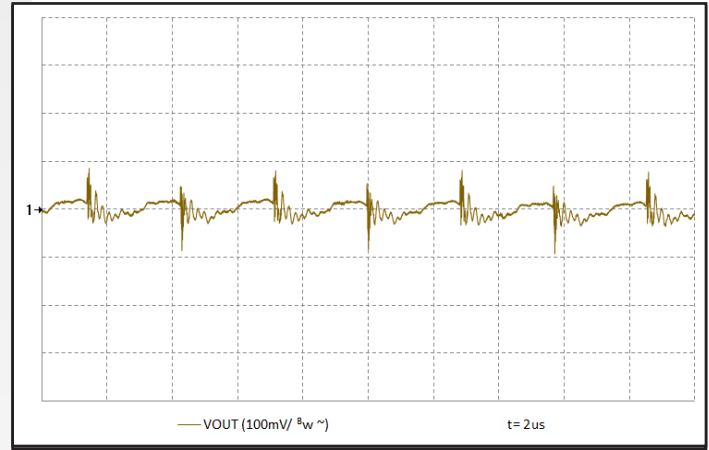

Figure 16: Output voltage ripple, V_{out} , at nominal input voltage and full load, 470uF output capacitance (100 mV/div). Bandwidth: 20MHz. Timescale: 2.00 μ s/div. See Figure 12.

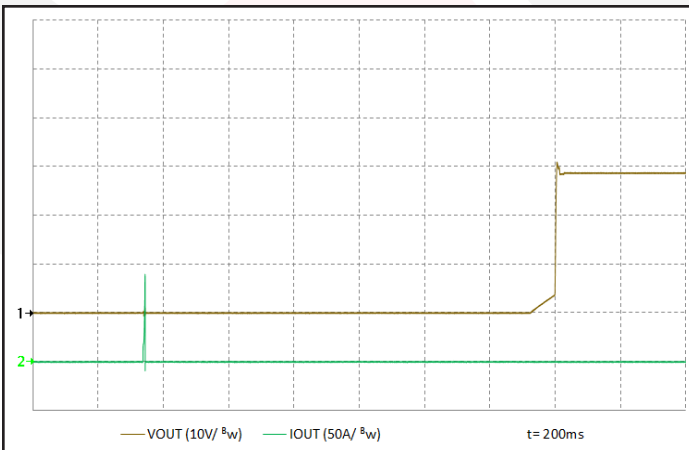

Figure 17: Rise of output voltage when a short circuit across the output terminals is removed after 30 seconds. See Figure E. $R_{short} = 5 m\Omega$, zero output capacitance. Ch1: V_{out} (10 V/div). Ch 2: I_{out} (50 A/div). Bandwidth: 20MHz. Timescale: 200ms/div.



MCOTS-B-900-28-FT
Input: 800-1000 V
Output: 28 V
Current: 107 A

Application Section

BASIC OPERATION AND FEATURES

With voltages dropping and currents rising, the economics of an Intermediate Bus Architecture (IBA) are becoming more attractive, especially in systems requiring multiple low voltages. IBA systems separate the role of isolation and voltage scaling from regulation and sensing. The BusQor series bus converter provides isolation and an unregulated voltage step down in one compact module, leaving regulation to simpler, less expensive non-isolated converters.

In Figure A below, the BusQor module provides the isolation stage of the IBA system. The isolated bus then distributes power to the non-isolated buck regulators to generate the required voltage levels at the points of load. In this case, the bucks are represented with SynQor's NiQor series of non-isolated DC-DC converters. In many applications requiring multiple low voltage outputs, significant savings can be achieved in board space and overall system costs.

When designing an IBA system with bus converters, the designer can select from a variety of bus voltages. While there is no universally ideal bus voltage, most designs employ either 270 V, 48 V, or 28 V. The MCOTS-B-900-28-FT has been designed to provide a bus voltage of 28V when the input to the BusQor converter is 900V.

SynQor's BusQor modules act as a true dc transformer. The output voltage is proportional to the input voltage, with a specified "turns ratio" or voltage ratio, plus minor drop from the internal resistive losses in the module. When used in IBA systems, the output variation of the BusQor must be in accordance with the input voltage range of the non-isolated converters being employed.

The BusQor architecture is very scalable, meaning multiple bus converters can be connected directly in parallel to allow current sharing for higher power applications.

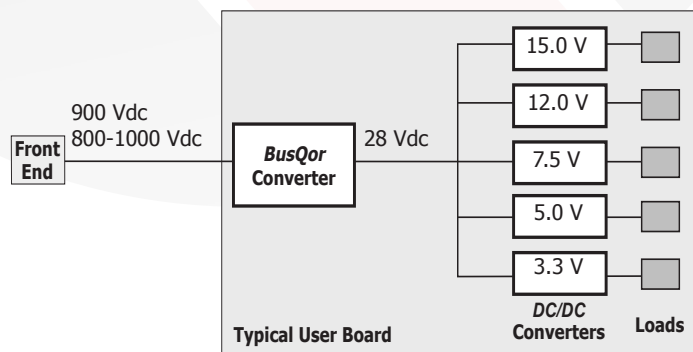

Figure A: Example of Intermediate Bus Architecture using isolated or non-isolated converters.

CONTROL FEATURES

REMOTE ON/OFF (Pin 4): The ON/OFF input, Pin 4, permits the user to control when the converter is on or off. This input is referenced to the return terminal of the input bus, Vin(-).

The ON/OFF signal is active low (meaning that a low voltage turns the converter on). Figure B is a detailed look of the internal ON/OFF circuitry.

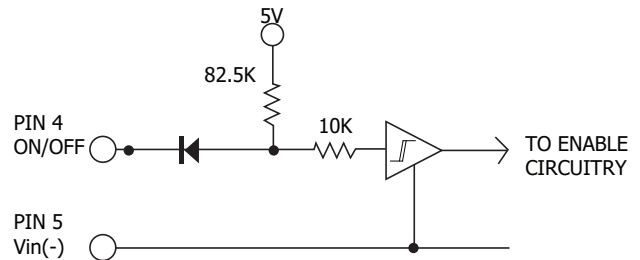

Figure B: Internal ON/OFF pin circuitry

SYNCHRONIZATION: The MCOTS converter's switching frequency can be synchronized to an external frequency source that is in the 300 kHz to 400 kHz range. An open drain pulse train at the desired frequency should be applied to the Sync In pin (pin 3) with respect to the Vin(-) (pin 5). This pulse train should have a duty cycle in the 20% to 80% range. The sync pin is internally pulled up to 3.3V using a 2.5 kOhm resistor. To guarantee synchronization the pin voltage must be driven below 0.8 V for a logic LOW and the voltage must be allowed to reach above 2.0 V for a logic HIGH. The transition time between the two states should be less than 300 ns.

If the MCOTS converter is not to be synchronized, the Sync In pin can be left open circuit. The converter will then operate in its free-running mode at a frequency of approximately 350 kHz (twice the switching frequency).

During a fault, if the Sync In pin is held in a logic low state, the converter will not run when enabled. If the Sync In pin is held in a logic high state or the Sync In frequency is outside the 300-400 kHz range, the MCOTS converter will revert to its free-running frequency.

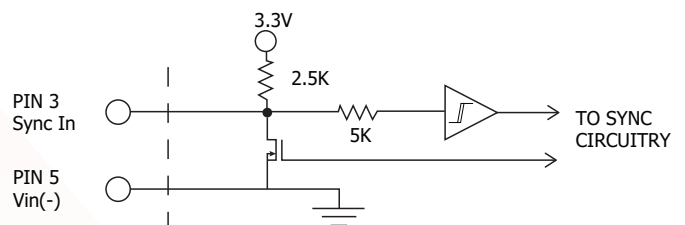

Figure C: Equivalent circuit looking into the Sync In pin with respect to the Vin(-) (input return) pin.



Application Section

PROTECTION FEATURES

Input Under-Voltage Lockout: The converter is designed to turn off when the input voltage is too low, helping avoid an input system instability problem, described in more detail in the application note titled "Input System Instability". The lockout circuitry is a comparator with DC hysteresis. When the input voltage is rising, it must exceed the typical Turn-On Voltage Threshold value (listed on the specification page) before the converter will turn on. Once the converter is on, the input voltage must fall below the typical Turn-Off Voltage Threshold value before the converter will turn off. Also see Figure F.

Input Over-Voltage Shutdown: The converter also has a two stage over-voltage feature that limits the converter's duty cycle for 100 ms before shutdown and a higher second level with no delay before shutdown if the input voltage is too high (See the Input Over-Voltage Shutdown section in the Electrical Characteristics Table for specific voltage levels). It also has a hysteresis and time delay to ensure proper operation.

Input Under-Voltage Shutdown: The converter includes a two stage under-voltage feature that allows the unit to continue running when input voltage is above the minimum transient voltage and an automatic shutdown with no delay when below the minimum transient voltage (See the Input Under-Voltage Lockout section in the Electrical Characteristics Table for specific voltage levels).

Over Current / Short Circuit Protection: The converter uses current limit and short circuit shutdown features to protect itself from output overload conditions. When the converter is running and the load current exceeds the Output DC Current Limit Inception (typically 127 A, page 3), the unit will try to regulate the load current for ~ 2 ms (output voltage will droop). If the load current does not return to an acceptable level within this 2 ms interval, the unit will shut down. If a peak current greater than 150 A is detected, then the short circuit fault will shut down the converter with zero delay.

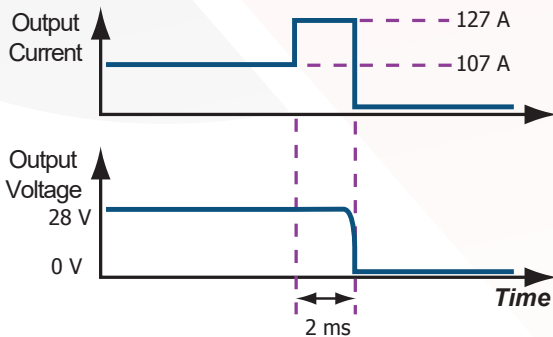

Figure D: Output Overload protection diagram (not to scale)

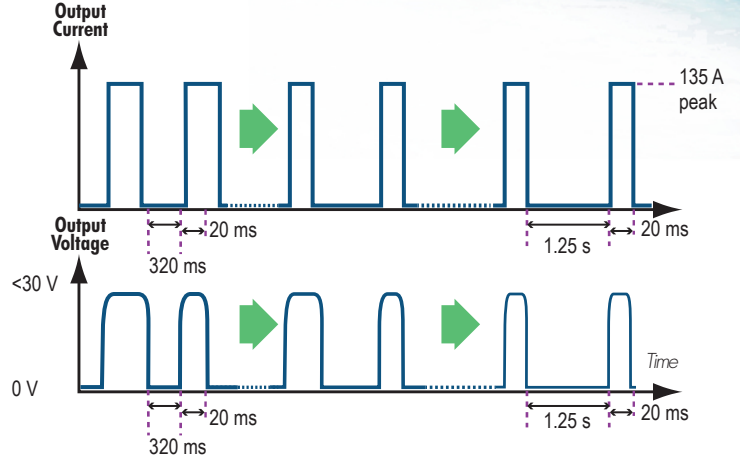

Figure E: Output Short Circuit and Auto-Resetting protection diagram (not to scale)

Should the current rise too quickly at startup, the unit will engage its short circuit protection early, disabling the unit. This is possible by using a varying short circuit trigger. With Nominal input voltage the short circuit trigger is set to approximately 135 A (Figure E). Whether the unit is disabled from an over current or a short circuit event, the unit will remain off for ~ 320 ms (unit inhibit period). After the inhibit period, the unit will attempt to restart. To avoid a failed restart, limit the startup load to 9 mF capacitance and / or 53 A resistive load. If the fault condition persists, the module will repeat restart and shutdown cycles, each time increasing the inhibit period by ~ 34 ms up to a maximum of a 1.25 S. The Bus Qor product returns (auto resetting) to normal operation once the fault condition is cleared. The module is designed to survive in this mode of operation indefinitely without damage and / or human intervention.

In the auto resetting mode, also referred to as "Hiccup" mode, the average power drawn from the input is ~ 10 Watts, most of which is dissipated into the external fault. The duty cycle of the hiccup characteristic has been designed to prevent damage to itself and / or its parent PCB. Connections to the output pins must be designed to withstand short-term peak currents in excess of 200 A.

Over-Temperature Shutdown: A temperature sensor on the converter senses the average temperature of the module. The thermal shutdown circuit is designed to turn the converter off when the temperature at the sensed location reaches the Over-Temperature Shutdown value. It will allow the converter to turn on again when the temperature of the sensed location falls by the amount of the Over-Temperature Shutdown Restart Hysteresis value.

APPLICATION CONSIDERATIONS

Start-Up Inhibit Period: Figure F details the Start-Up Inhibit Period for the BusQor module. At time t_0 , the On/Off pin is asserted (enabled), and the BusQor input voltage (V_{in}) begins to rise. Before time t_1 , when the input voltage is below the UVL threshold, the unit is disabled by the Input Under-Voltage Lockout feature. At time t_1 , when the input voltage rises above the UVL threshold, the Input Under-Voltage Lockout is released and a typical Initial Startup Inhibit Period of 15 ms is initiated. The output rises to 90% of the nominal value of 28 V in a period of 100 ms typical (50% load). Once the unit has reached steady state operation (~ 120 ms after time t_1), the unit can be loaded to its full rated output current.

At time t_2 , when the On/Off pin is de-asserted (disabled), the BusQor output instantly drops to 0 V. Fall time from 28 V to 0 V is dependent on output capacitance and any parasitic trace inductance in the output load circuit.

At time t_3 , when the On/Off pin is re-asserted (enabled), the BusQor module will restart after the inhibit period (320 ms typical) has elapsed.

Refer to the Control Features section of the data sheet for details on enabling and disabling methods for Bus Qor modules.

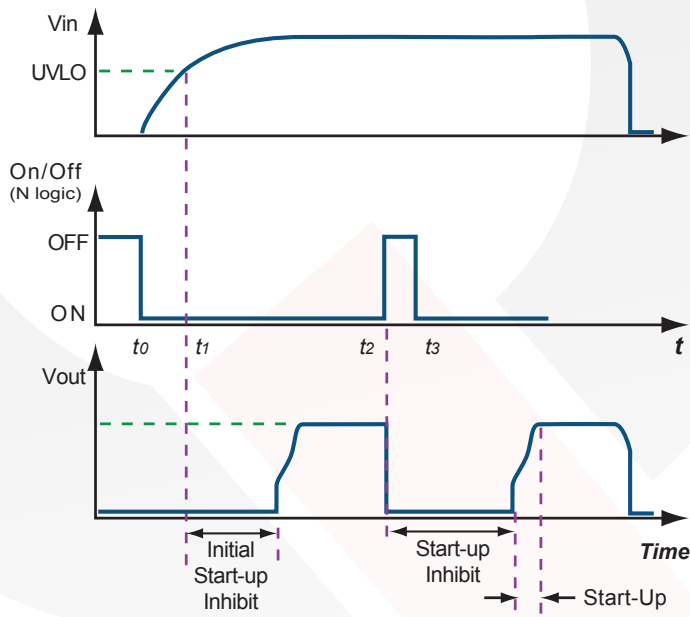

Figure F: Power Up/Down Diagram (not to scale) showing Start-Up Inhibit Period

Thermal Derating Test Setup

The curves showing the derating of output current and power as a function of the baseplate temperature are taken with the oven setup shown in Fig. G. The converter module is soldered to a carrier PCB that is mounted horizontally within an oven. The carrier PCB is a four layer 4 oz PCB. A large aluminum heatsink (thermal grease is applied between the baseplate and the heatsink interface to minimize the thermal impedance) is attached to the baseplate to keep the baseplate temperature constant during thermal testing. A small hole is drilled through the heatsink in order to attach a thermocouple to the baseplate of the DUT. Additional thermocouples are attached to the hottest components before baseplating to monitor the internal temperature of all of the critical components during testing. The oven temperature is controlled so as to keep the baseplate temperature to the desired value. The baseplate temperature is kept at 90-100 °C or below for all conditions. If the temperature of an internal component exceeds 125 °C, the output current (power level) is reduced so as to keep the temperature of all internal components below 125 °C.

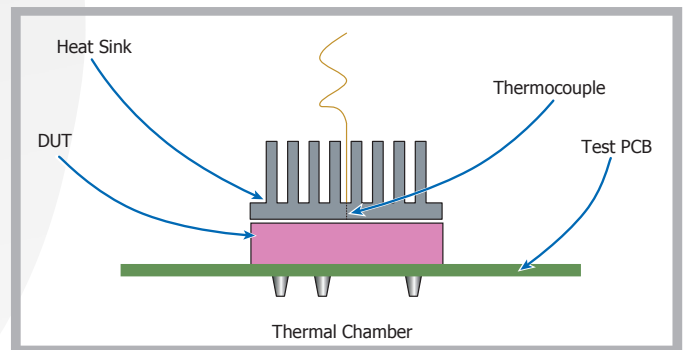

Figure G: Thermal chamber setup for derating curves.



MCOTS-B-900-28-FT
Input: 800-1000 V
Output: 28 V
Current: 107 A

Application Section

Current Sharing: MCOTS BusQor modules are designed to operate in parallel without the use of any external current share circuitry. Current sharing is achieved through “Droop Share”. An output capacitor (47uF minimum) is recommended across each module and located close to the converter for optimum filtering and noise control performance. Dedicated input inductors are recommended but are considered optional. Input capacitors must be located close to the converter module. PCB layout in the input circuit should be such that high frequency ripple currents of each module is restricted to a loop formed by the input capacitors and the input terminals of the BusQor module. See Figure H for details on PCB layout. Contact SynQor application engineering for further assistance on PCB trace design.

The current share performance of two paralleled modules is illustrated in the graph in Figure I. In this graph the percent deviation from ideal sharing (50%) is plotted for each module versus the total output load current at 900 Vin. Two MCOTS 900 Bus Qor’s will share within 10% at higher loads. The current share accuracy is affected by changes in the gate drive timing. The gate drive timing is adjusted as a function of load to better optimize the product efficiency over line and load (performance), resulting in higher load share deviations at lighter loads.

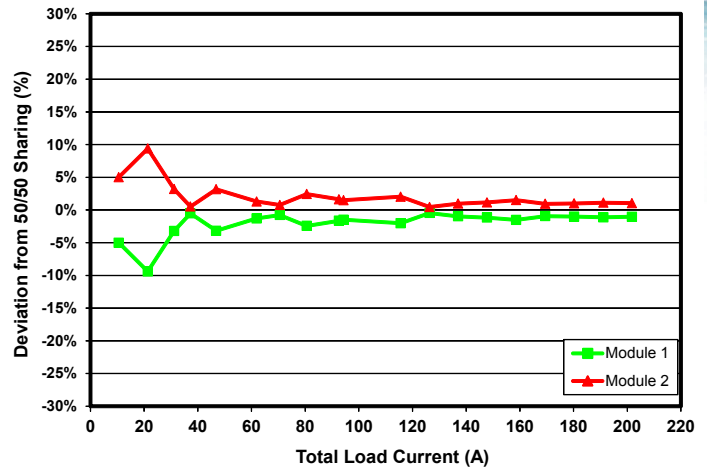

Figure I: Typical current share performance of 2 paralleled modules

Sync Start: The Sync In pin can also be used to synchronize the start-up of multiple modules. To implement this feature, connect the Sync In pins of all the units connected in parallel. This will permit immediate start-up with loads greater than the current limit of a single unit. Without this connection, any set of converters attempting to asynchronously start (or restart) with a load greater than the current limit of a single unit will immediately shut down, initiating a new “hiccup” cycle. This “hiccup” mode will continue until one converter attempts a start at the same time as the minimum number of additional units necessary to sustain the load condition. For example, the MCOTS-B-900-28-FT can start up into about 53A resistive load. Three of the same units starting into a 90A load would require two units to simultaneously attempt a start. The Start Sync connection synchronizes these starting attempts and provides a more consistent and reliable start-up sequence.

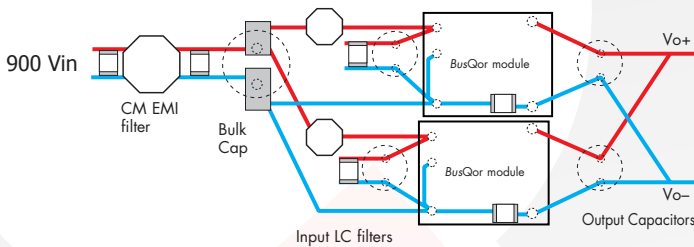
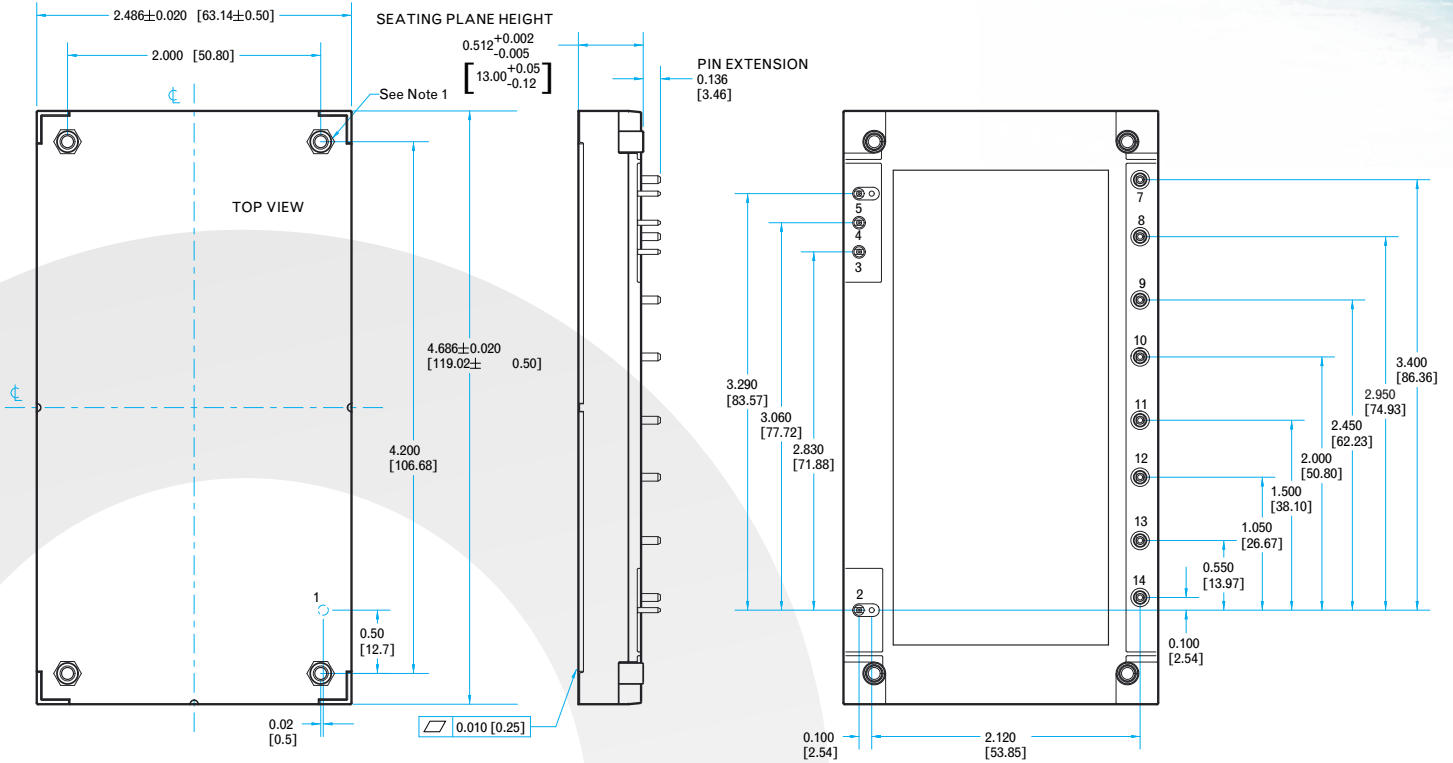

Figure H: Recommended physical implementation of two BusQor’s in parallel.



MCOTS-B-900-28-FT
Input: 800-1000 V
Output: 28 V
Current: 107 A

Encased Mechanical Diagram



NOTES

- 1) Recommended torque per M3 screw is 6 in-lb (0.7 Nm). Threaded or non-threaded options available.
- 2) Baseplate flatness tolerance is 0.010" (.25 mm) TIR for surface
- 3) Other pin extension lengths available
- 4) Pins 2-5 are 0.040" (1.02 mm) dia. with 0.080" (2.03 mm) dia. standoff shoulders
- 5) Pins 7-14 are 0.062" (1.57 mm) dia. with 0.100" (2.54 mm) dia. standoff shoulders
- 6) All pins: Material: Copper Alloy
Finish: Matte Tin over Nickel plate
- 7) Undimensioned components are shown for visual reference only
- 8) Weight: 10.0 oz (285g) typical
- 9) All dimensions in inches(mm)
Tolerances: x.xx in +/-0.02 (x.x mm +/-0.5 mm)
x.xxx in +/-0.010 (x.xx mm +/-0.25 mm)

PIN DESIGNATIONS

Pin	Name	Function
2	Vin(+)	Positive Input Voltage
3	Sync In	Clock synchronization / Start Sync
4	ON/OFF	TTL input to turn converter on and off, referenced to Vin(-) with internal pull up
5	Vin(-)	Negative input voltage
7	Vout(-)	Negative output voltage
8	Vout(+)	Positive output voltage
9	Vout(-)	Negative output voltage
10	Vout(+)	Positive output voltage
11	Vout(-)	Negative output voltage
12	Vout(+)	Positive output voltage
13	Vout(-)	Negative output voltage
14	Vout(+)	Positive output voltage

Flanged Encased Mechanical Diagram

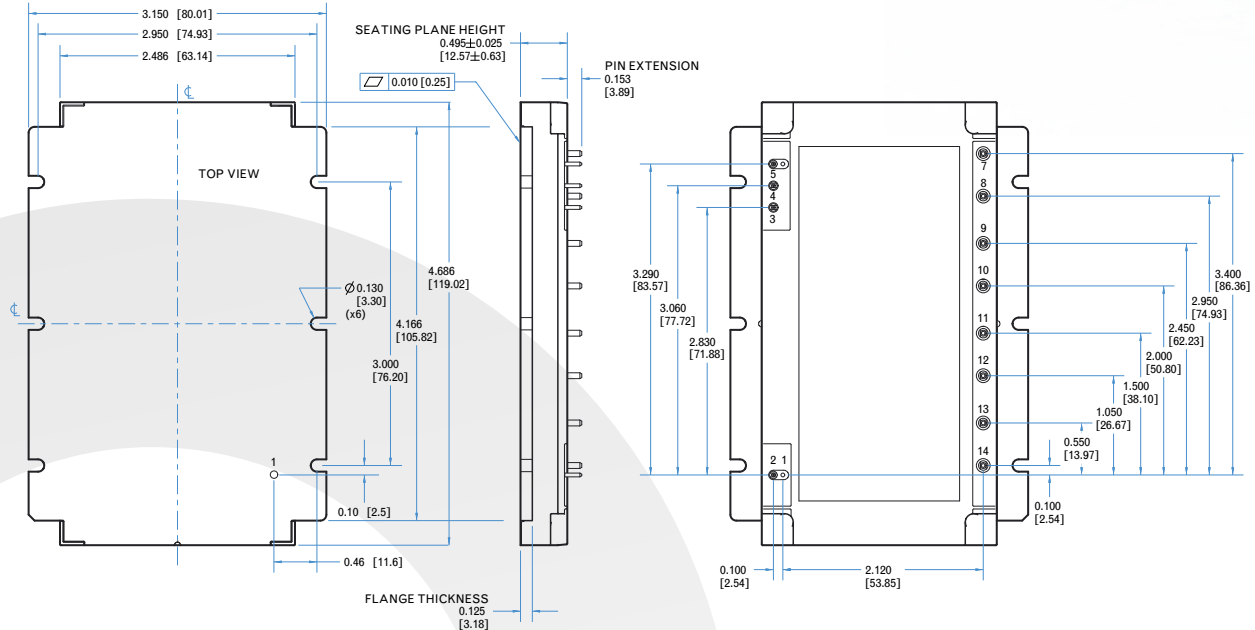

NOTES

- 1) Recommended torque per M3 or 4-40 screw is 6 in-lb (0.7 Nm).
- 2) Baseplate flatness tolerance is 0.010" (.25 mm) TIR for surface
- 3) Other pin extension lengths available
- 4) Pins 2-5 are 0.040" (1.02 mm) dia. with 0.080" (2.03 mm) dia. standoff shoulders
- 5) Pins 7-14 are 0.062" (1.57 mm) dia. with 0.100" (2.54 mm) dia. standoff shoulders
- 6) All pins: Material: Copper Alloy
Finish: Matte Tin over Nickel plate
- 7) Undimensioned components are shown for visual reference only
- 8) Weight: 10.5 oz (298 g) typical
- 9) All dimensions in inches(mm)
Tolerances: x.xx in +/-0.02 (x.x mm +/-0.5 mm)
x.xxx in +/-0.010 (x.xx mm +/-0.25 mm)

PIN DESIGNATIONS

Pin	Name	Function
2	Vin(+)	Positive Input Voltage
3	Sync In	Clock synchronization / Start Sync
4	ON/OFF	TTL input to turn converter on and off, referenced to Vin(-) with internal pull up
5	Vin(-)	Negative input voltage
7	Vout(-)	Negative output voltage
8	Vout(+)	Positive output voltage
9	Vout(-)	Negative output voltage
10	Vout(+)	Positive output voltage
11	Vout(-)	Negative output voltage
12	Vout(+)	Positive output voltage
13	Vout(-)	Negative output voltage
14	Vout(+)	Positive output voltage



MCOTS-B-900-28-FT
Input: 800-1000 V
Output: 28 V
Current: 107 A

Qualifications & Screening

Mil-COTS Qualification

Test Name	Details	# Tested (# Failed)	Consistent with MIL-STD-883F Method
Life Testing	Visual, mechanical and electrical testing before, during and after 1000 hour burn-in @ full load	15 (0)	Method 1005.8
Shock-Vibration	Visual, mechanical and electrical testing before, during and after shock and vibration tests	5 (0)	MIL-STD-202, Methods 201A & 213B
Humidity	+85 °C, 95% RH, 1000 hours, 2 minutes on / 6 hours off	8 (0)	Method 1004.7
Temperature Cycling	500 cycles of -55 °C to +100 °C (30 minute dwell at each temperature)	10 (0)	Method 1010.8, Condition A
Solderability	15 pins	15 (0)	Method 2003
DMT	-65 °C to +110 °C across full line and load specifications in 5 °C steps	7 (0)	
Altitude	70,000 feet (21 km), see Note	2 (0)	

Note: A conductive cooling design is generally needed for high altitude applications because of naturally poor convective cooling at rare atmospheres.

Mil-COTS Converter and Filter Screening

Screening	Process Description	S-Grade	M-Grade
Baseplate Operating Temperature		-55 °C to +100 °C	-55 °C to +100 °C
Storage Temperature		-65 °C to +135 °C	-65 °C to +135 °C
Pre-Cap Inspection	IPC-A-610, Class III	•	•
Temperature Cycling	MIL-STD-883F, Method 1010, Condition B, 10 Cycles		•
Burn-In	100 °C Baseplate	12 Hours	96 Hours
Final Electrical Test	100%	25 °C	-55 °C, +25 °C, +100 °C
Final Visual Inspection	MIL-STD-883F, Method 2009	•	•

Mil-COTS MIL-STD-810G Qualification Testing

MIL-STD-810G Test	Method	Description
Fungus	508.6	Table 508.6-I
Altitude	500.5 - Procedure I	Storage: 70,000 ft / 2 hr duration
	500.5 - Procedure II	Operating: 70,000 ft / 2 hr duration; Ambient Temperature
Rapid Decompression	500.5 - Procedure III	Storage: 8,000 ft to 40,000 ft
Acceleration	513.6 - Procedure II	Operating: 15 g
Salt Fog	509.5	Storage
High Temperature	501.5 - Procedure I	Storage: 135 °C / 3 hrs
	501.5 - Procedure II	Operating: 100 °C / 3 hrs
Low Temperature	502.5 - Procedure I	Storage: -65 °C / 4 hrs
	502.5 - Procedure II	Operating: -55 °C / 3 hrs
Temperature Shock	503.5 - Procedure I - C	Storage: -65 °C to 135 °C; 12 cycles
Rain	506.5 - Procedure I	Wind Blown Rain
Immersion	512.5 - Procedure I	Non-Operating
Humidity	507.5 - Procedure II	Aggravated cycle @ 95% RH (Figure 507.5-7 aggravated temp - humidity cycle, 15 cycles)
Random Vibration	514.6 - Procedure I	10 - 2000 Hz, PSD level of 1.5 g ² /Hz (54.6 g _{rms}), duration = 1 hr/axis
Shock	516.6 - Procedure I	20 g peak, 11 ms, Functional Shock (Operating no load) (saw tooth)
	516.6 - Procedure VI	Bench Handling Shock
Sinusoidal vibration	514.6 - Category 14	Rotary wing aircraft - helicopter, 4 hrs/axis, 20 g (sine sweep from 10 - 500 Hz)
Sand and Dust	510.5 - Procedure I	Blowing Dust
	510.5 - Procedure II	Blowing Sand



MCOTS-B-900-28-FT
Input: 800-1000 V
Output: 28 V
Current: 107 A

Ordering Section

Ordering Information/ Part Numbering

Example: MCOTS-B-900-28-FT-N-M

Not all combinations make valid part numbers, please contact SynQor for availability. See [product summary page](#) for details.

Family	Product	Input Voltage	Output Voltage	Package	Thermal Design	Screening Level	Options
MCOTS	B: Bus Converter	900: 800-1000 V	28: 28 V	FT: Full Brick Tera	N: Normal Threaded D: Normal Non-Threaded F: Flanged	S: S-Grade M: M-Grade	[]: Standard Feature

Application Notes

A variety of application notes and technical white papers can be downloaded in pdf format from our website.

Contact SynQor for further information and to order:

Phone: 978-849-0600 **Toll Free:** 888-567-9596 **Fax:** 978-849-0602

E-mail: power@synqor.com **Web:** www.synqor.com

Address: 155 Swanson Road, Boxborough, MA 01719 USA

WARRANTY

SynQor offers a two (2) year limited warranty. Complete warranty information is listed on our website or is available upon request from SynQor.

PATENTS

SynQor holds numerous U.S. patents, one or more of which apply to most of its power conversion products. Any that apply to the product(s) listed in this document are identified by markings on the product(s) or on internal components of the product(s) in accordance with U.S. patent laws. SynQor's patents include the following:

7,050,309 7,765,687 7,787,261
 8,149,597 8,644,027